

Systemplan!
Details laut Türliste!
Türliste ist vorrangig!
 Leibungen müssen in allen Richtungen im Blei sein, damit es funktioniert!

Bei LBW-Wand mit UA-Profil durch Gipser!

 RS Suter AG im Wängli 4a 8910 Affoltern am Albis Tel. 052 232 87 77 info@rs-suter.ch	Plan Nr. <p style="text-align: center;">1.1/1.6</p>
	Auftrags Nr. <p style="text-align: center;">18002</p>
Suchtbehandlung Frankental Emil-Klötistr. 14-18, 8037 Zürich Typ 1.1	Revision 31.7.18
	Datum <p style="text-align: center;">19.7.18</p>
	Massstab <p style="text-align: center;">1:16 / 1:2 A3</p>
	Gezeichnet <p style="text-align: center;">PS</p>

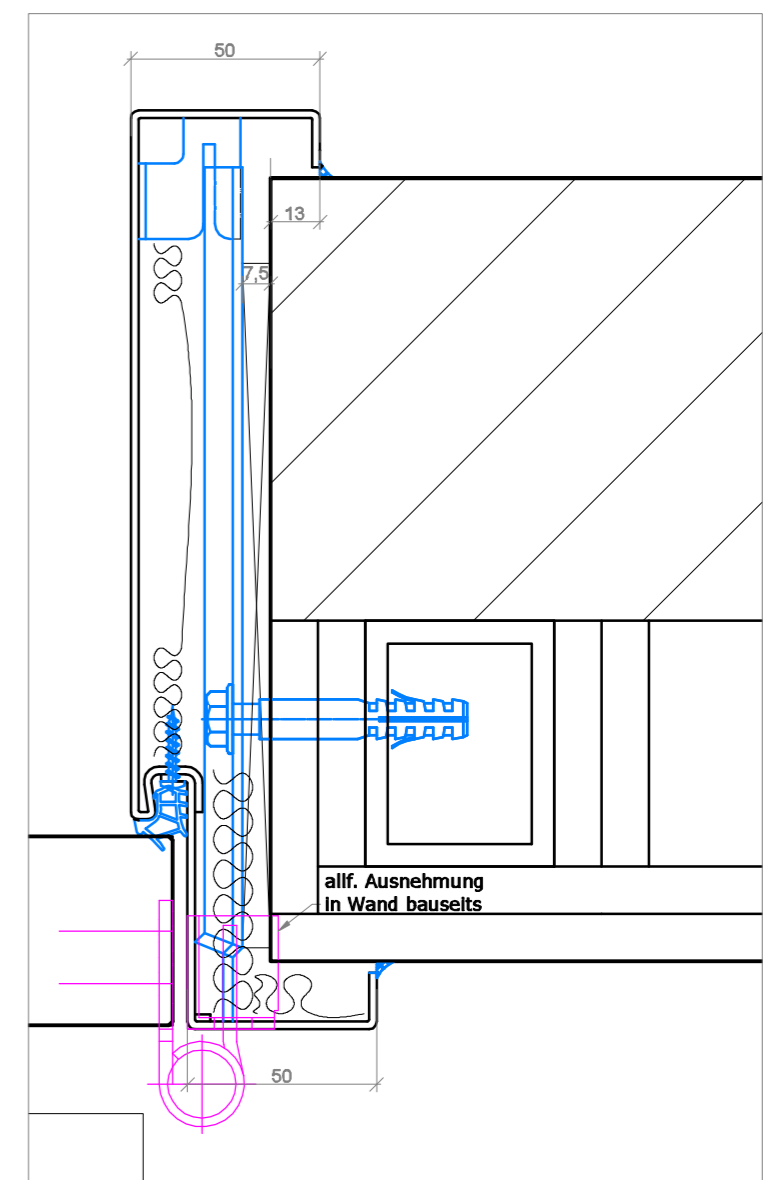
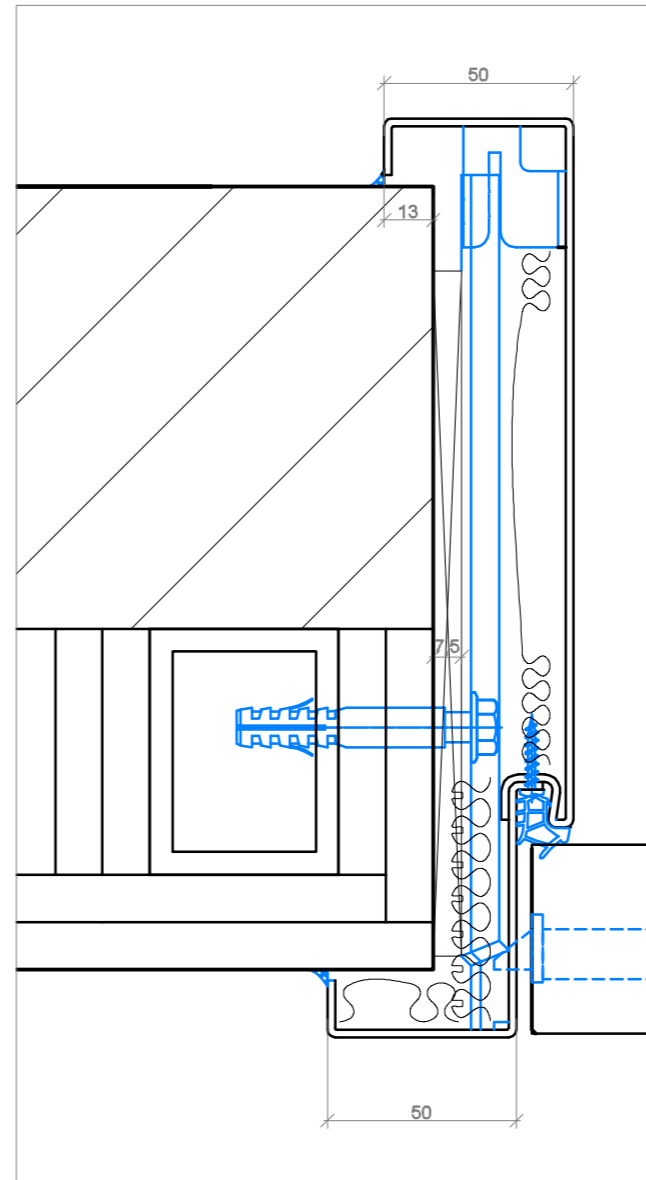
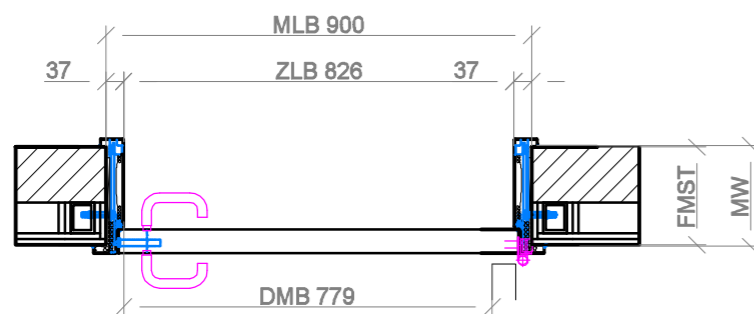
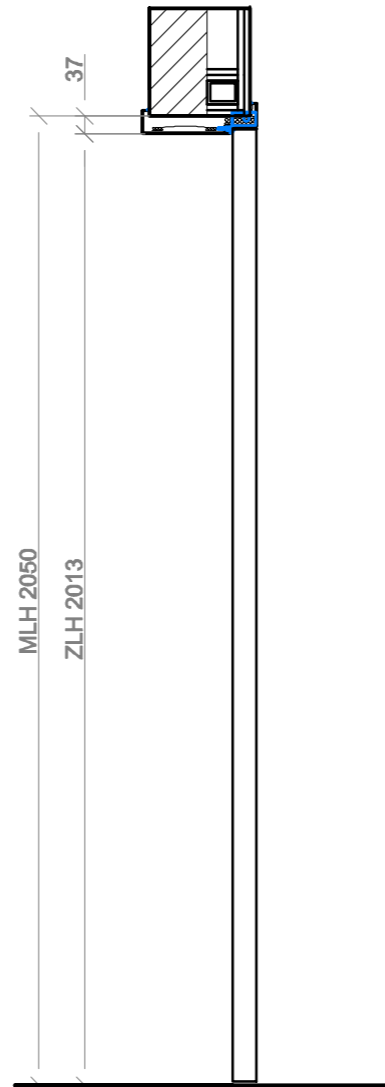
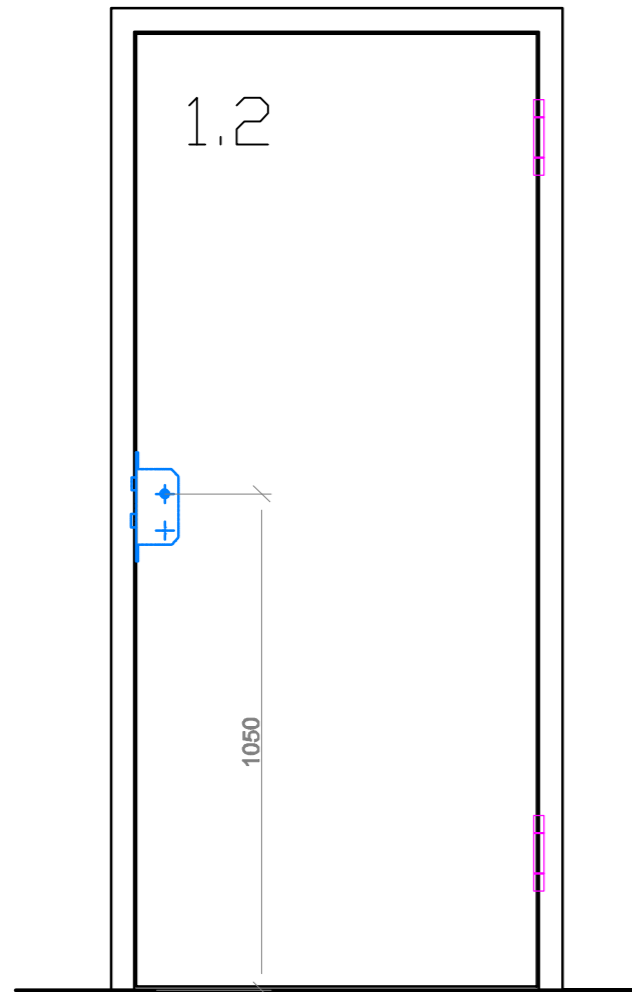

Systemplan!
Details laut Türliste!
Türliste ist vorrangig!
Leibungen müssen in allen Richtungen im Blei sein, damit es funktioniert!

Vorsatzschale muss bei EI30 Türe mittels verkleidetem EI60 geprüfem Stahlbauteil bauseits erfolgen, ringsum die Tür!

RS Suter AG
 im Wängli 4a
 8910 Affoltern am Albis
 Tel. 052 232 87 77
 info@rs-suter.ch

Suchtbehandlung Frankental

Emil-Klötistr. 14-18, 8037 Zürich

Typ 1.2

Plan Nr.

1.2

Revision

Auftrags Nr.

18002

Datum

19.7.18

Massstab

1:16 / 1:2 A3

Gezeichnet

PS

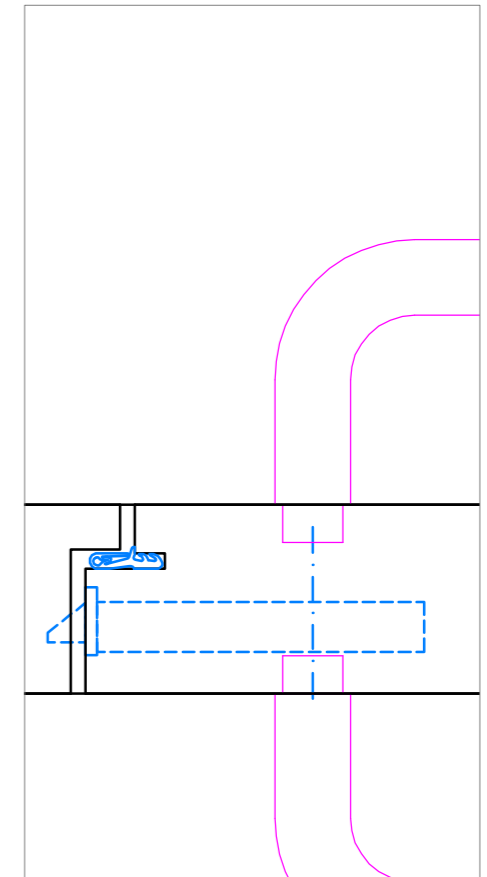
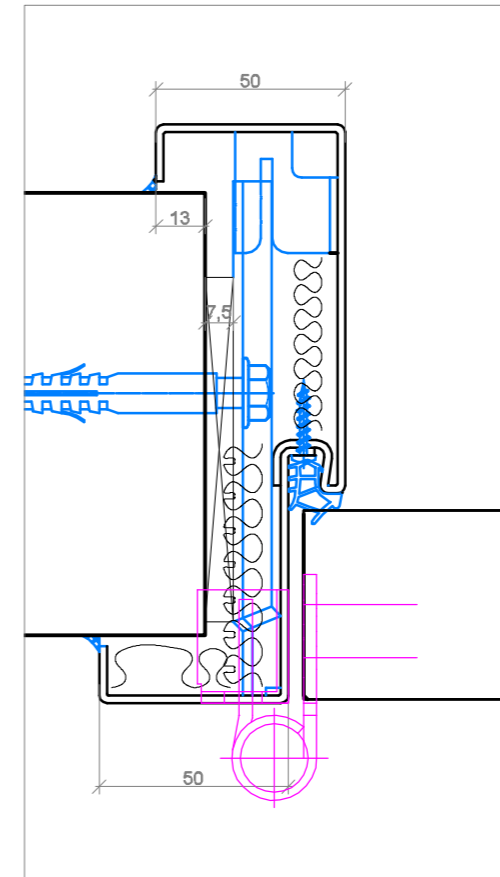
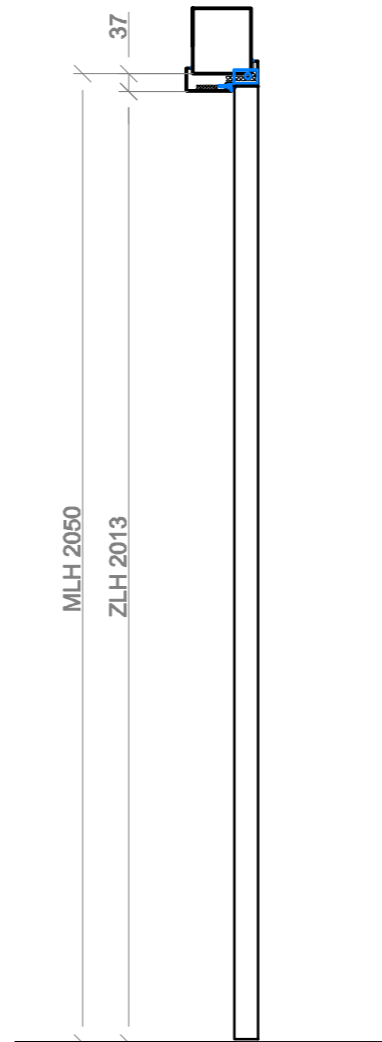
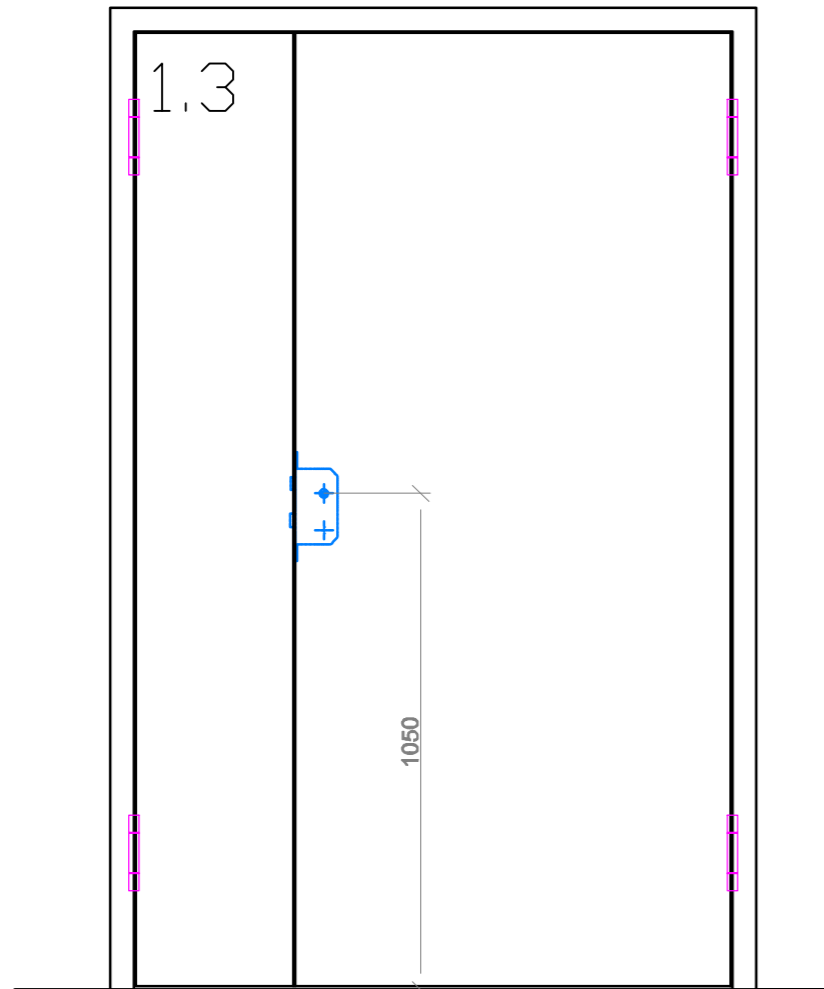

Systemplan!
Details laut Türliste!
Türliste ist vorrangig!
Leibungen müssen in allen Richtungen im Blei sein, damit es funktioniert!

ITS96GSR nicht möglich, Gehfl: mind. 750mm und Standflügel mind. 540mm!

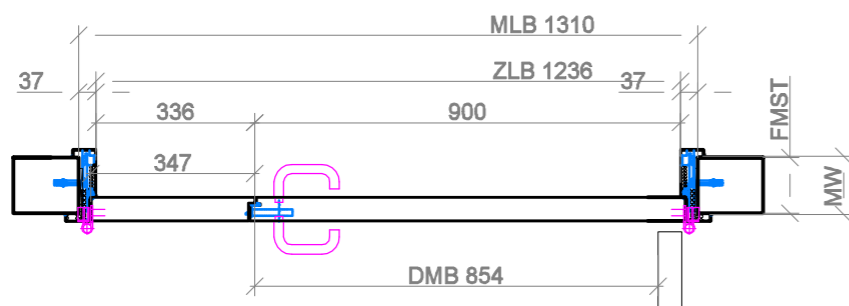

RS
RS Suter AG
 im Wängli 4a
 8910 Affoltern am Albis
 Tel. 052 232 87 77
 info@rs-suter.ch

Suchtbehandlung Frankental

Emil-Klötistr. 14-18, 8037 Zürich

Typ 1.3

Plan Nr.

1.3

Revision

Auftrags Nr.

18002

Datum

19.7.18

Massstab

1:16 / 1:2 A3

Gezeichnet

PS

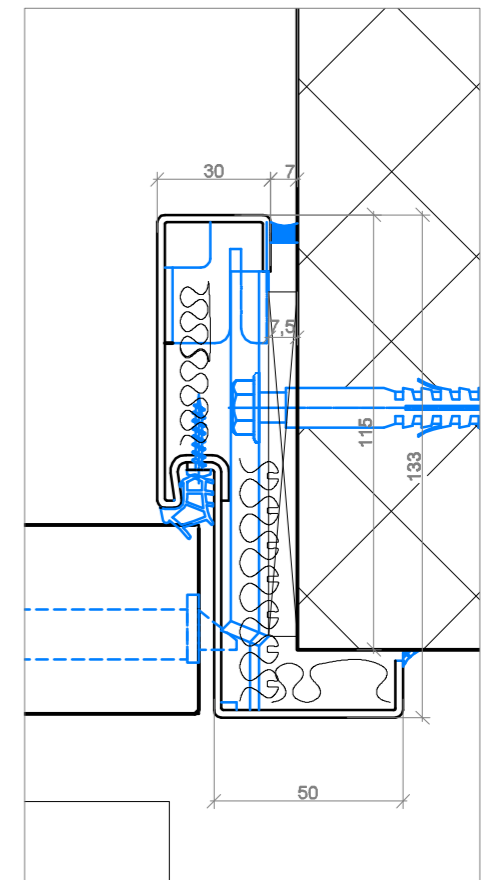
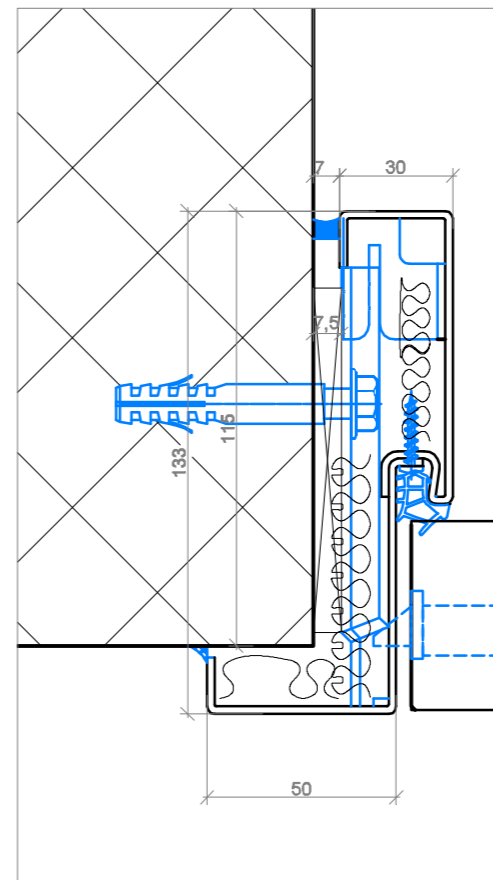
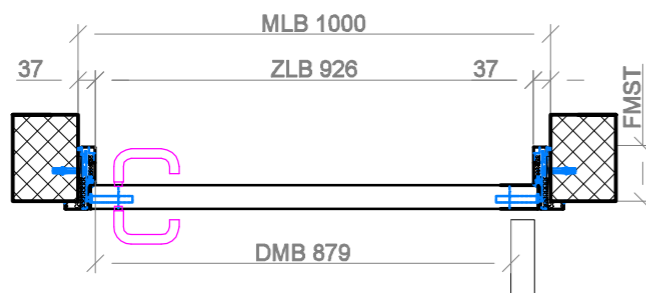
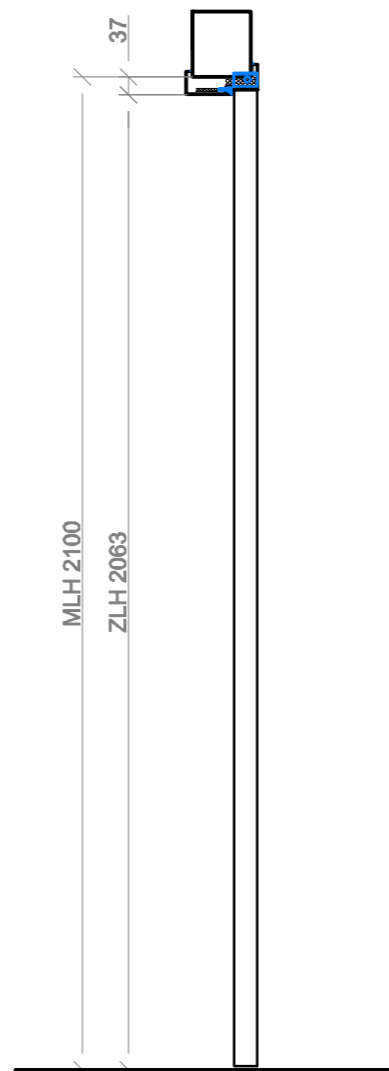
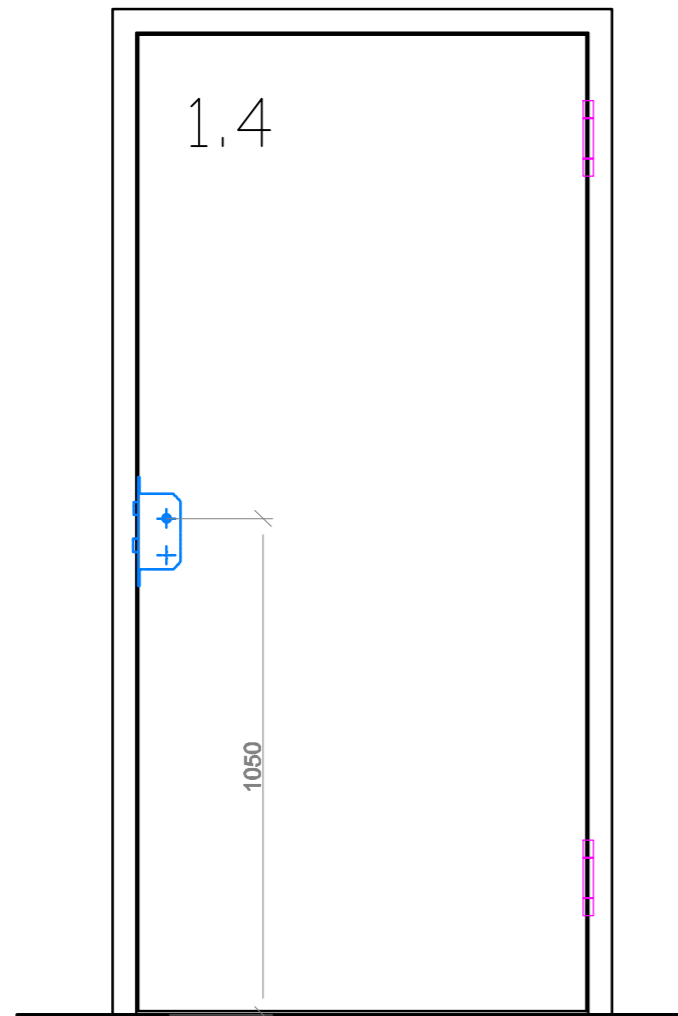

Systemplan!
 Details laut Türliste!
 Türliste ist vorrangig!
 Leibungen müssen in allen Richtungen im Blei sein, damit es funktioniert!

RS Suter AG
 im Wängli 4a
 8910 Affoltern am Albis
 Tel. 052 232 87 77
 info@rs-suter.ch

Suchtbehandlung Frankental
 Emil-Klötistr. 14-18, 8037 Zürich
 Typ 1.4

Plan Nr.	1.4
Auftrags Nr.	18002
Datum	19.7.18
Massstab	1:16 / 1:2 A3
Gezeichnet	PS

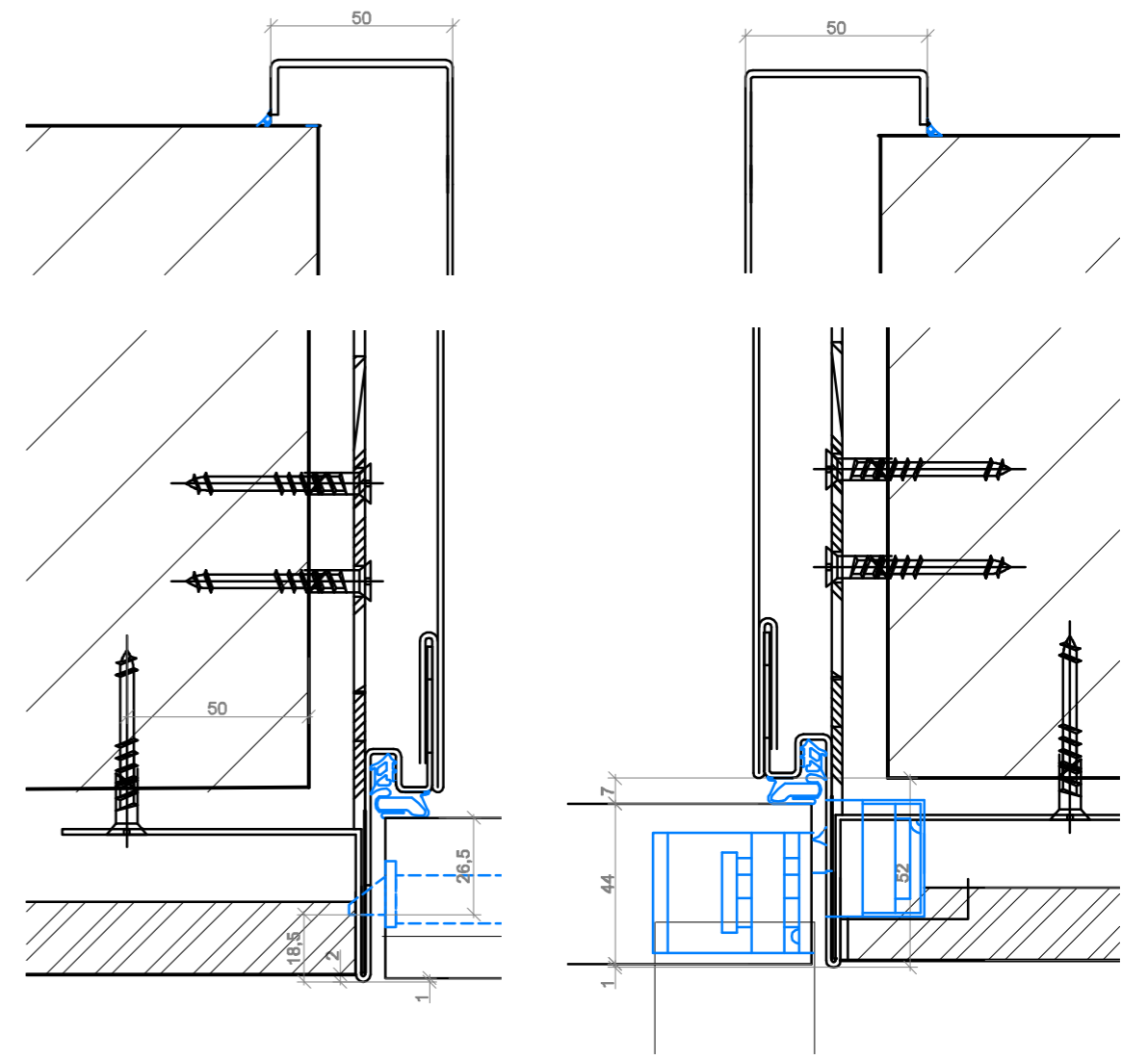
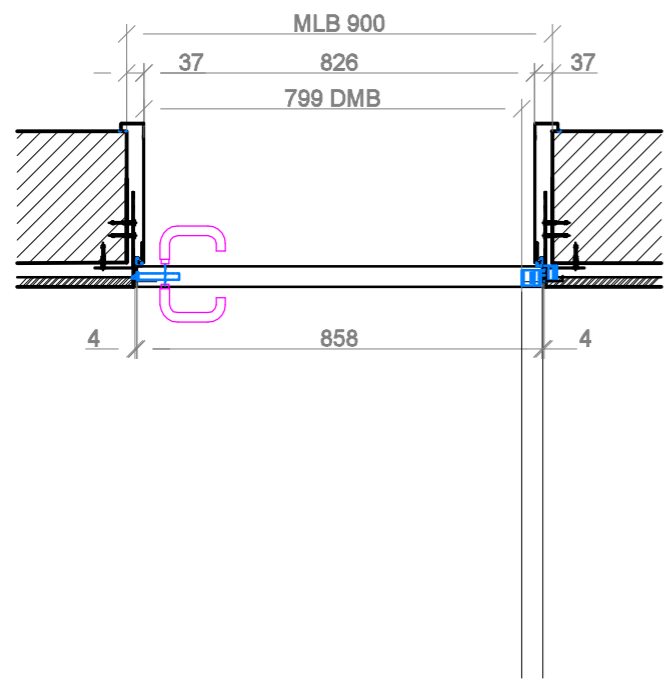
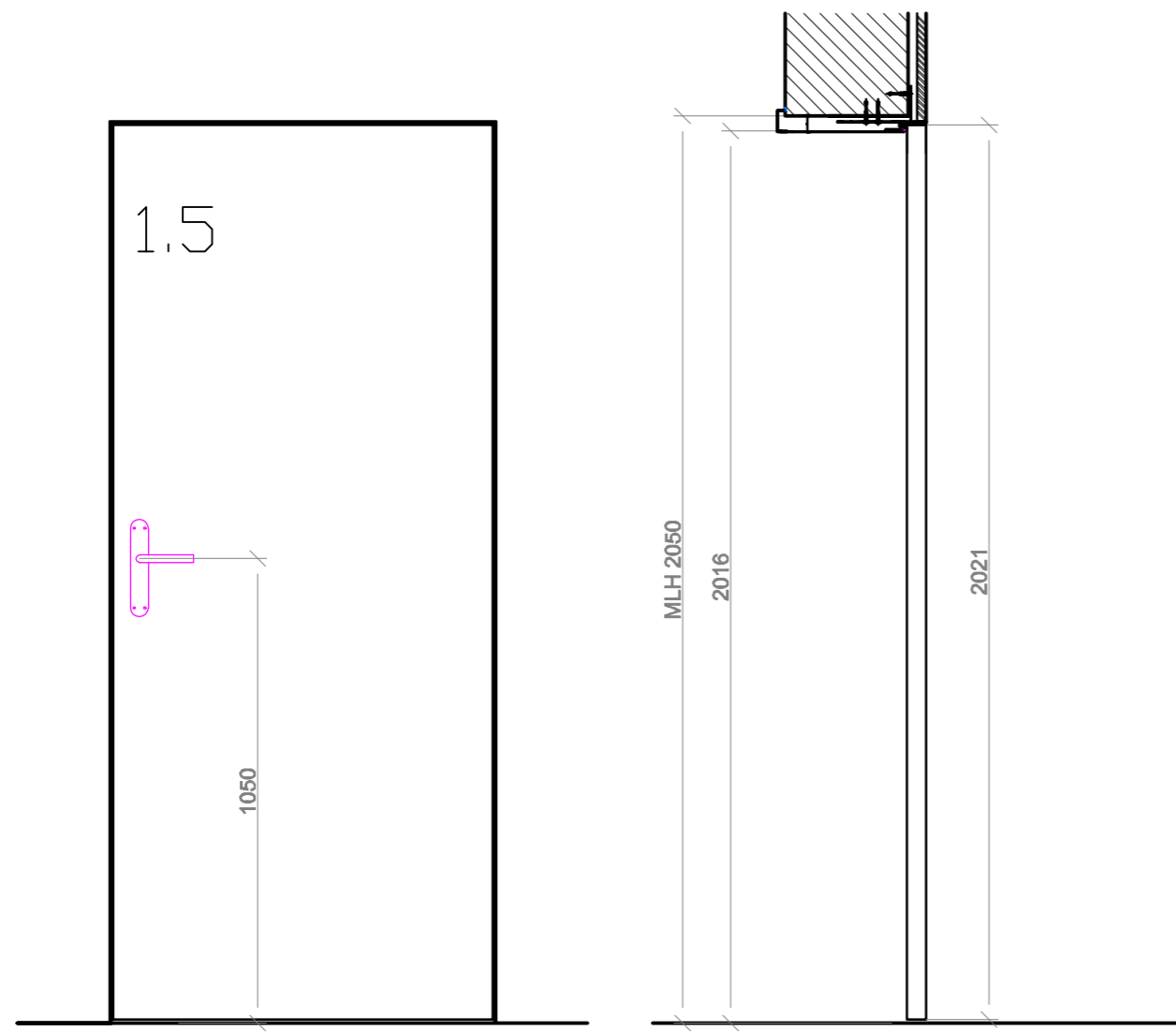

Systemplan!
Masse laut Zargenliste Lieferant!
Zargenliste Lieferant ist vorrangig!

 RS Suter AG im Wängli 4a 8910 Affoltern am Albis Tel. 052 232 87 77 info@rs-suter.ch	Revision 15.4.19	Plan Nr. 1.5
	Suchtbehandlung Frankental	Auftrags Nr. 18002
Emil-Klötistr. 14-18, 8037 Zürich	Datum 19.7.18	Massstab 1:16 / 1:2 A3
Typ 1.5	Gezeichnet PS	

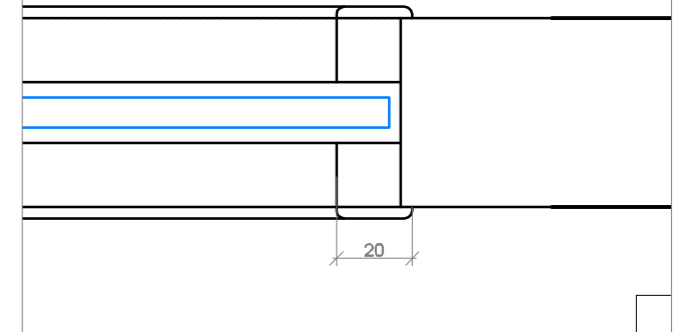
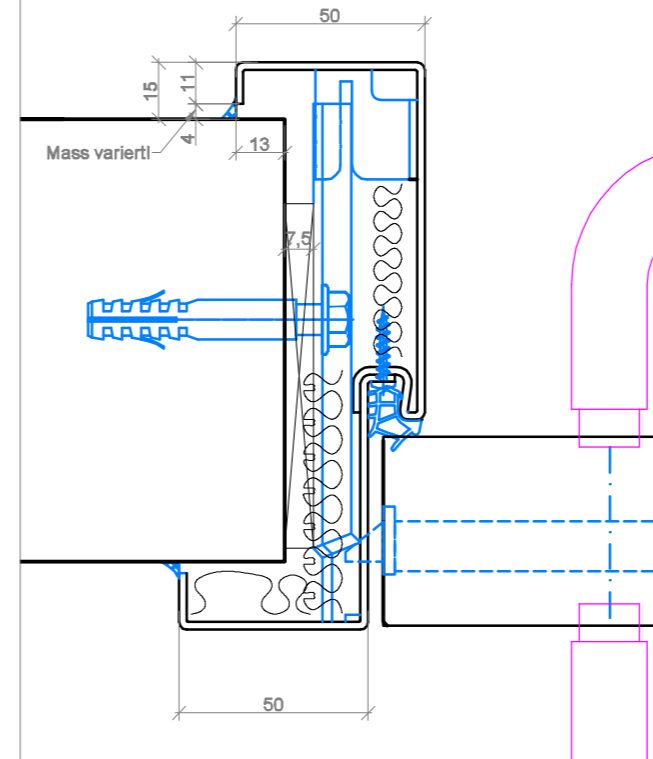
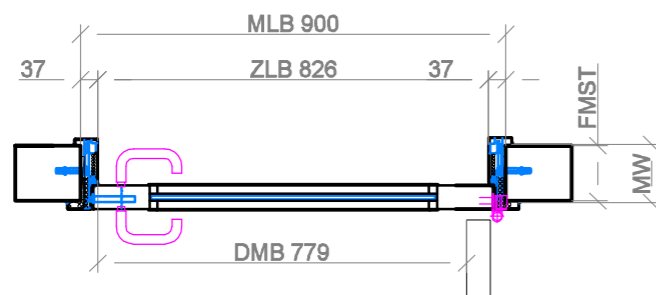
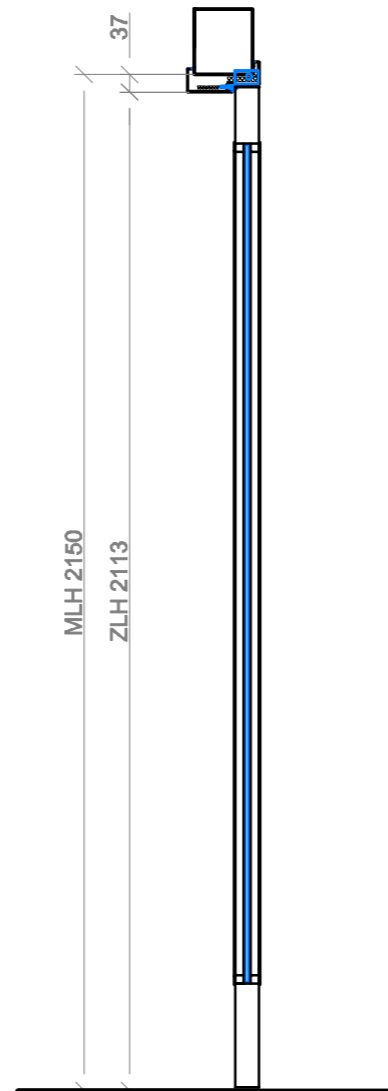
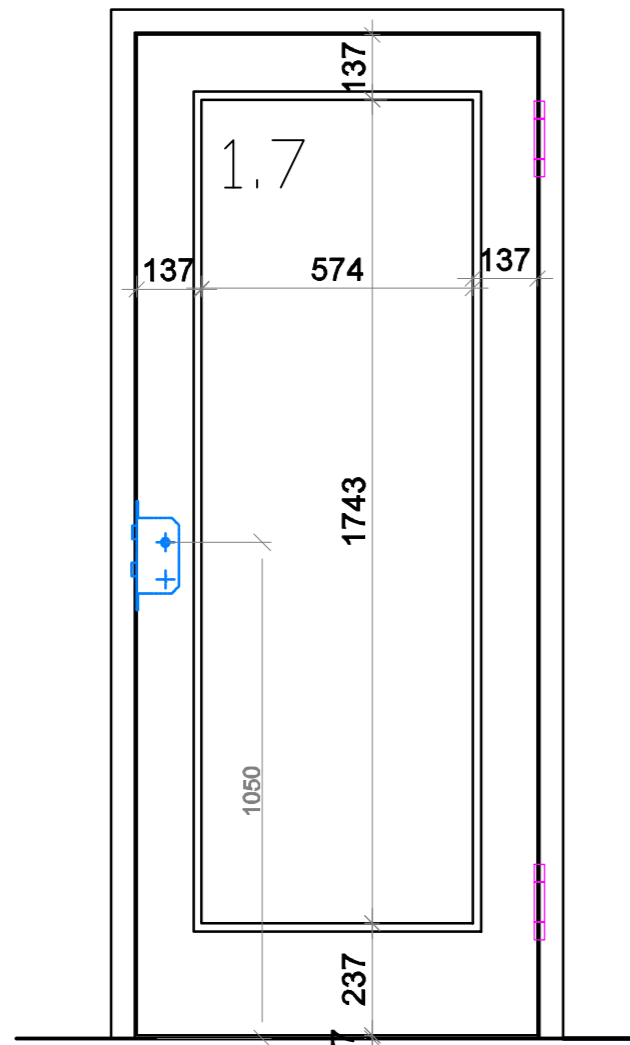

Systemplan!
Details laut Türliste!
Türliste ist vorrangig!
Leibungen müssen in allen Richtungen im Blei sein, damit es funktioniert!

 RS Suter AG im Wängli 4a 8910 Affoltern am Albis Tel. 052 232 87 77 info@rs-suter.ch	Plan Nr.	1.7
	Suchtbehandlung Frankental Emil-Klötistr. 14-18, 8037 Zürich Typ 1.7	Auftrags Nr. 18002 Datum 31.7.18 Massstab 1:16 / 1:2 A3 Gezeichnet PS